







■ Pilot Operated Check Modular Valves

■ Specifications

Model Numbers	Max. Operating Pressure Kgf/cm ²	Max. Flow L/Min.
MPA-06※-※-※-30H01/70	250	500
MPB-06※-※-※-30H01/70	{For 70 Design	
MPW-06※-※-※-30H01/70	350}	

Graphic Symbols

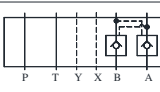
Pilot-Drain Type Model No.	Internal Pilot- Internal drain type	External Pilot- External drain type	External Pilot- Internal drain type
MPA-06	 MPA-06-※	 MPA-06※-※-X	 MPA-06※-※-Y
MPB-06	 MPB-06-※	 MPB-06※-※-X	 MPB-06※-※-Y
MPW-06	 MPW-06-※		

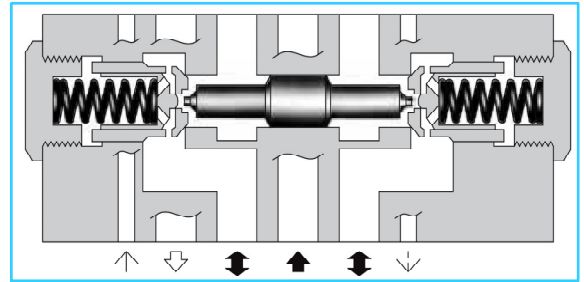

■ Model Number Designation

F-	MPA	-06	S	-2	-X	-30	H01
Special Seals	Series Number	Valve Size	Port Tapping Feature of Pilot-Drain Port *1	Cracking Pressure Kgf/cm ²	Pilot-Drain *2 Connection	Design Number	Design Standard
F: Special Seal For Phosphate Ester Type Fluids (Omit if not required)	MPA: Pilot Operated Check for A-Line MPB: Pilot Operated Check for B-Line MPW: Pilot Operated Check for A-B-line	06	None : Taper Thread S: Straight Thread (Applicable only for Japanese std. "JIS")	2 : 2 4 : 4	None: Internal Pilot-Internal Drain X : External Pilot-External Drain Y : External Pilot-Internal Drain	30 70	H01 -

*1 This item applies only to External Pilot or External Drain Type.

*2 For MPW valves, 'X' & 'Y' options are not applicable.

● **MP※-06-※-30H01**

■ **Typical Performance Characteristics**

Hydraulic Fluid: Viscosity 35cSt, Specific Gravity 0.850

● **Pressure Drop**

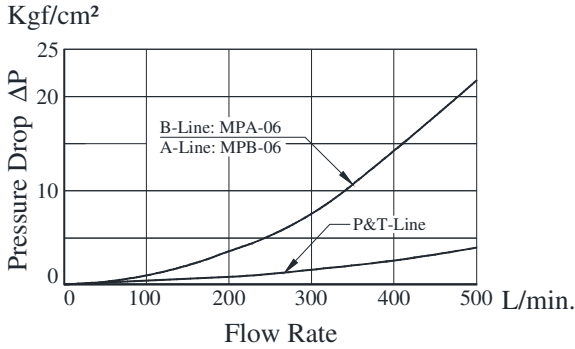

● **Pressure Drop for Reversed Controlled Flow**

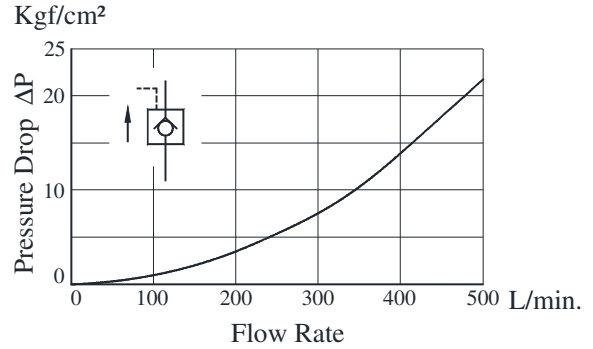

● **Pressure Drop for Free Flow**

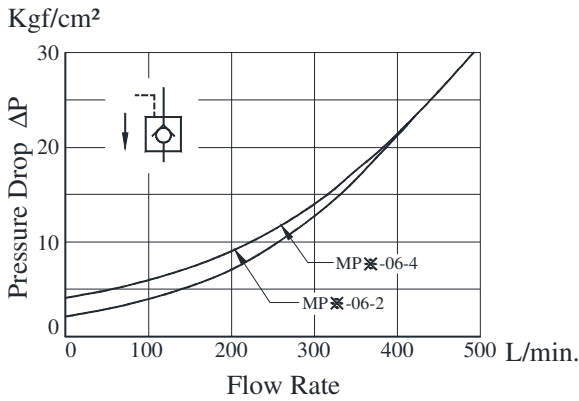

● **Min. Pilot Pressure**

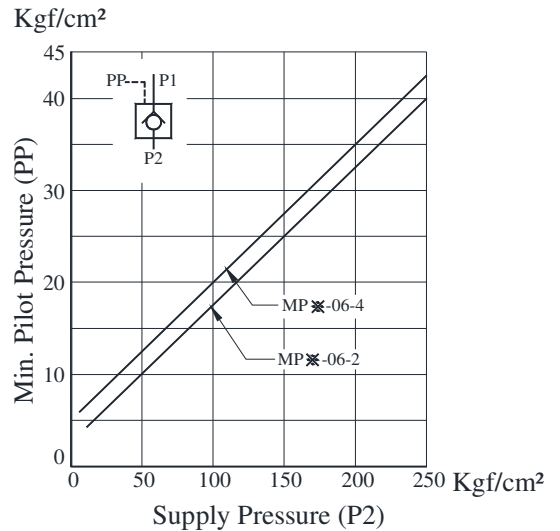

● **MP※-06-※-70**

■ **Typical Performance Characteristics**

Hydraulic Fluid: Viscosity 35cSt, Specific Gravity 0.850

● **Pressure Drop**

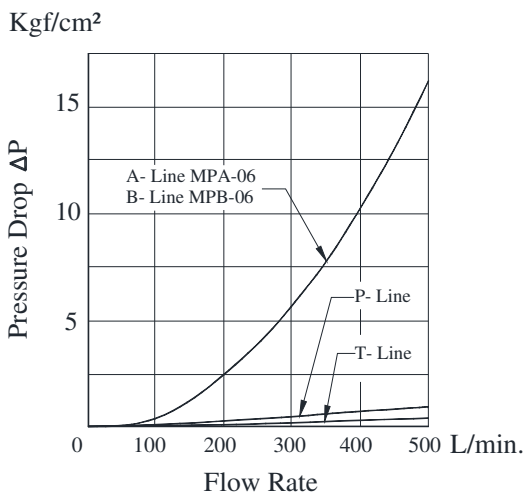

● **Pressure Drop for Reversed Controlled Flow**

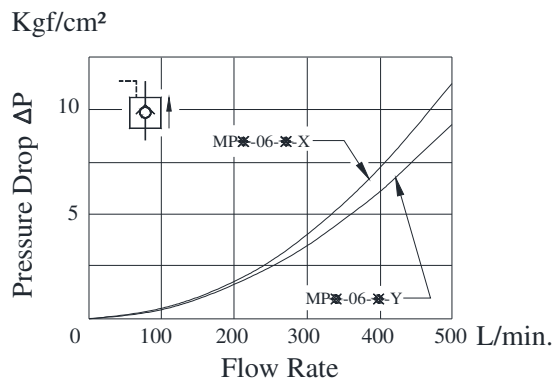

● **Pressure Drop for Free Flow**

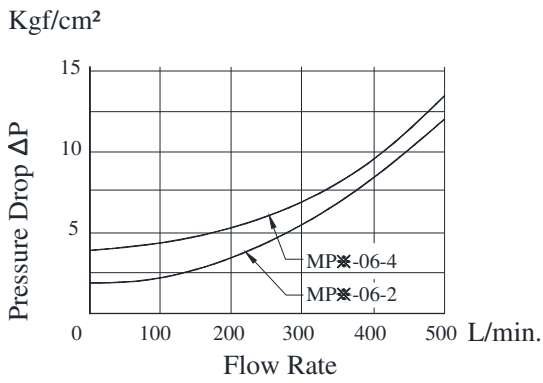

● **Min. Pilot Pressure**

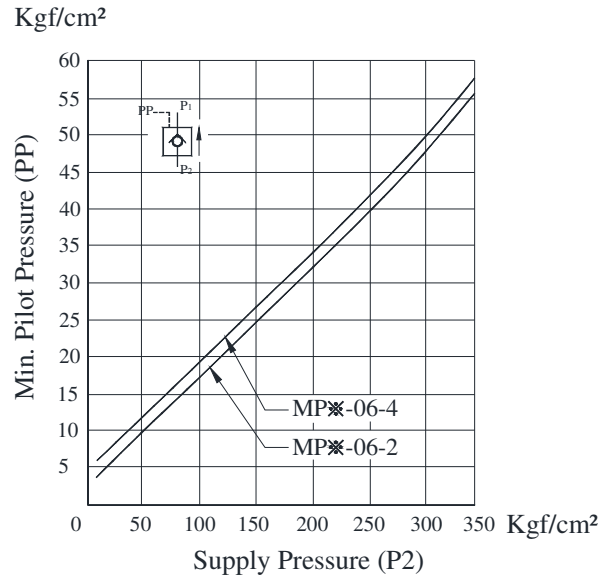

- **MPA-06-※-30H01**
- **MPB-06-※-30H01** (Internal Pilot-Internal Drain Type)
- **MPW-06-※-30H01**

DIMENSIONS IN MILLIMETRES

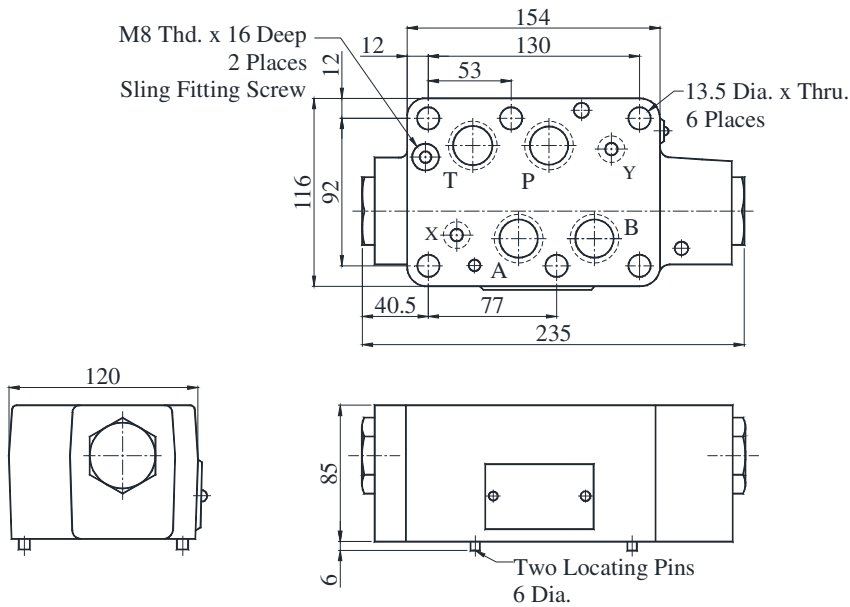

Approx. Mass..... 11.6 Kg.

● **MPA-06-※-※-X-70 (External Pilot-External Drain Type)**

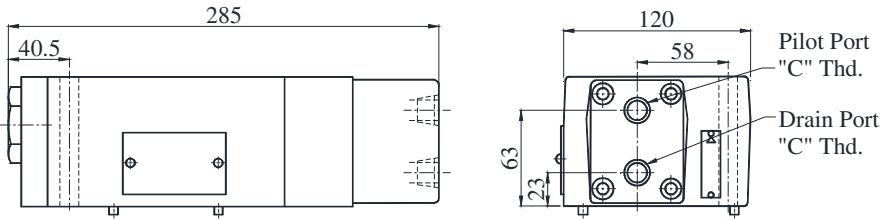

DIMENSIONS IN MILLIMETRES

Approx. Mass..... 13 Kg.

● **MPA-06-※-※-Y-70 (External Pilot-Internal Drain Type)**

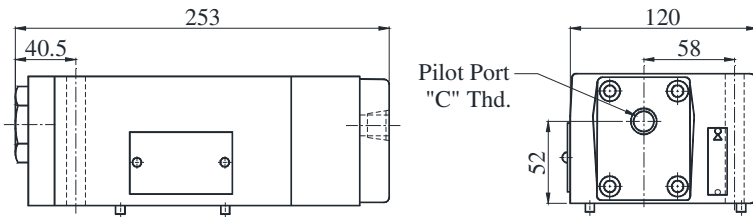

Model Numbers	Thread Size "C" Thd.
MPA-06-※-※-70	Rc 1/4 = 1/4 BSP.Tr.
MPA-06S-※-※-70	G 1/4

Approx. Mass..... 11.6 Kg.

● For other dimensions, refer to "Internal Pilot-Internal drain type" drawing above.

● **MPB-06-※-※-X-70 (External Pilot-External Drain Type)**

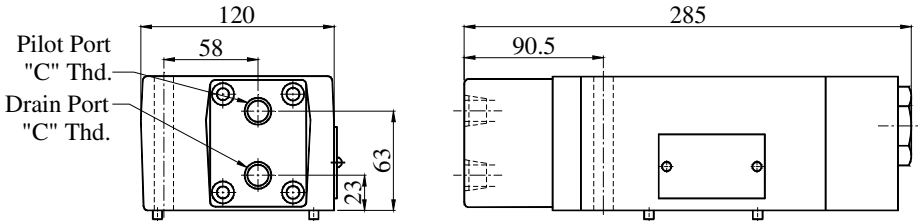

Approx. Mass..... 13 Kg.

● **MPB-06-※-※-Y-70 (External Pilot-Internal Drain Type)**

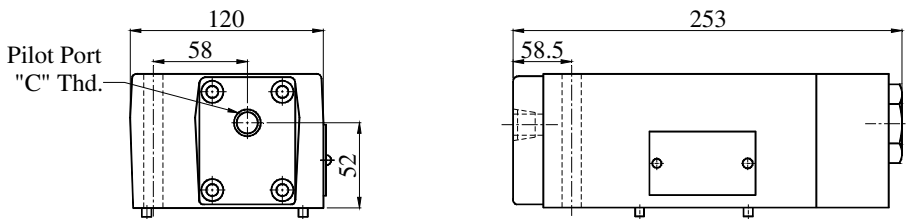

DIMENSIONS IN MILLIMETRES

Approx. Mass..... 11.6 Kg.

● For other dimensions, refer to "Internal Pilot-Internal drain type" drawing above.

Model Numbers	Thread Size "C" Thd.
MPB-06-※-※-70	Rc 1/4 = 1/4 BSP.Tr.
MPB-06S-※-※-70	G 1/4

Spare Parts List

● **List of Seals**

Sl. No.	Name of Parts	Part Nos.	Quantity		
			Internal Pilot-Internal Drain	External Pilot-External Drain	External Pilot-Internal Drain
1	O-Ring	SO-NB-P14	2	2	2
2	O-Ring	SO-NA-P26	-	1	-
3	O-Ring	SO-NB-P28	4	4	4
4	O-Ring	SO-NB-P32	2	1	1
5	O-Ring	SO-NB-P36	-	1	1

Note : When ordering the seals, please specify the seal kit numbers from the table below.

● **List of Seal Kits**

Model Nos.	Seal Kit Numbers
MPA-06-※	KS-MPA-06-30
MPB-06-※	
MPW-06-※	
MPA-06※-※-X	KS-MPA-06-X-70
MPB-06※-※-X	
MPA-06※-※-Y	KS-MPA-06-Y-70
MPA-06※-※-Y	